



Robinet de douche pression équilibrée avec tête de douche pluie et douchette à glissière (PEX EXPANSION)

Caractéristiques

- RVA-9170-W0-P : Brut de valve pression équilibrée cyclique à 2 voies
- T25-9170-00-xx : Finition pour valve cyclique type P 2 voies
- TET-0808-41-xx : Tête de douche carrée 8"
- BRA-1612-84-xx : Bras de douche 16"
- DGL-2575-71P-xx : Douchette à glissière 1 jet
- RAC-9004-28-xx : Coude de raccordement mural carré

Finis disponibles

- CC : Chrome
KK : Noir mat

FR

Certifications /Standards

ASME A112.18.1 / CSA B125.1



Pressure balanced shower faucet with rain shower head and hand shower with slide bar (PEX EXPANSION)

Features

- RVA-9170-W0-P: Rough-in pressure balanced 2-way cycling valve
- T25-9170-00-xx: Trim for P type 2-way valve
- TET-0808-41-xx: 8" square shower head
- BRA-1612-84-xx: 16" shower arm
- DGL-2575-71P-xx: 1-spray hand shower with slide bar
- RAC-9004-28-xx: Square wall mount supply elbow

Available finishes

- CC : Chrome
KK : Matte black

EN

RVA-9170-W0-P

BARIL PRO

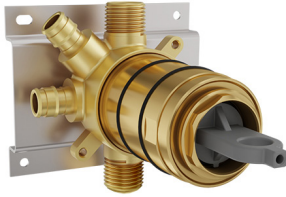

Caractéristiques

- Robinet cyclique de type P 2 voies
- Raccords 1/2" PEX EXPANSION aux entrées, 1 x sortie 1/2" PEX EXPANSION et 2 x sorties 1/2" NPT ou cuivre soudé
- Capuchon de test inclus
- Cartouche incluse avec la finition
- Débit de 5 gpm (19 L/min) @ 60 psi

FR

Certifications /Standards

ASME A112.18.1 / CSA B125.1



Features

- 2-way cycling P type faucet
- 1/2" EXPANSION PEX inlet, 1 x 1/2" EXPANSION PEX outlet and 2 x 1/2" NPT or welded copper outlet connections
- Test cap included
- Cartridge included with the trim
- Flow rate of 5 gpm @ 60 psi

EN



Finition pour valve cyclique type P 2 voies

Caractéristiques

- Sans vis apparentes
- Inclus cartouche cyclique dérivatrice 2 voies avec mécanisme de limitation de température
- Plaque de finition à clipser sur une sous-plaque
- Commandez l'un des bruts de valve suivants pour compléter la finition :
 - RVA-9170-00-P : Brut de valve pression équilibrée cyclique 2 voies (cartouche non-incluse) (cuivre soudé)
 - RVA-9170-00-P : Brut de valve pression équilibrée cyclique 2 voies (cartouche non-incluse) (PEX)
 - RVA-9170-00-P : Brut de valve pression équilibrée cyclique 2 voies (cartouche non-incluse) (PEX EXPANSION)

Finis disponibles

CC : Chrome

KK : Noir mat

FR

Certifications /Standards

ASME A112.18.1 / CSA B125.1



C

Trim for 2-way cycling P type valve

Features

- No visible screws
- Includes 2-way cycling diverter cartridge with temperature limiting device
- Trim plate supported by a clip plate
- Order one of the following rough-in valves to complete the trim:
 - RVA-9170-00-P: Rough-in pressure balanced 2-way cycling valve (cartridge non included) (welded copper)
 - RVA-9170-00-P: Rough-in pressure balanced 2-way cycling valve (cartridge non included)(PEX)
 - RVA-9170-00-P: Rough-in pressure balanced 2-way cycling valve (cartridge non included) (EXPANSION PEX)

Available finishes

CC : Chrome

KK : Matte black

EN

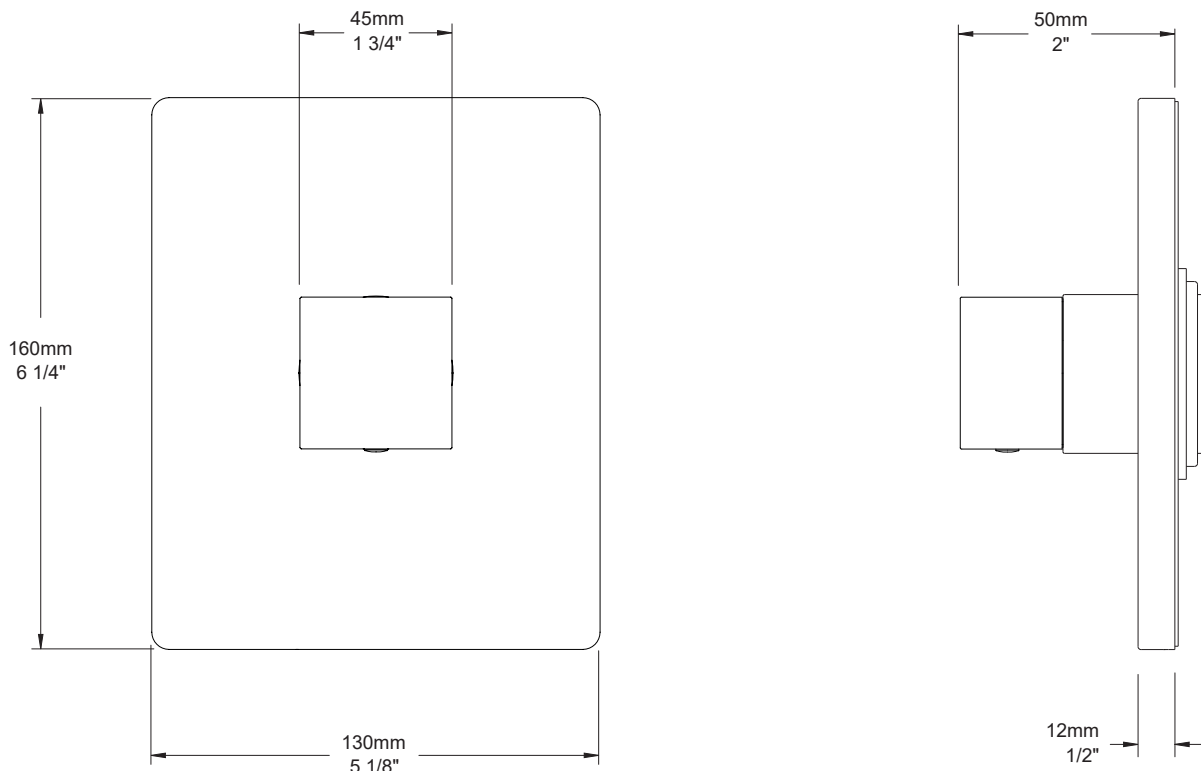



Tête de douche carrée 20 cm (8") en plastique

Caractéristiques

- Max : 1.75 gpm (6,6 L/min) @ 80 psi

Options d'économie d'eau

TET-0808-41-xx-150 : 5,7 L/min (1.5 gpm)

Finis disponibles

CC : Chrome

KK : Noir mat

FR

Certifications /Standards

ASME A112.18.1 / CSA B125.1



C



20 cm (8") square plastic shower head

Features

- Max: 1.75 gpm @ 80 psi

Water saving options

TET-0808-41-xx-150 : 5,7 L/min (1.5 gpm)

Available finishes

CC : Chrome

KK : Matte black

EN

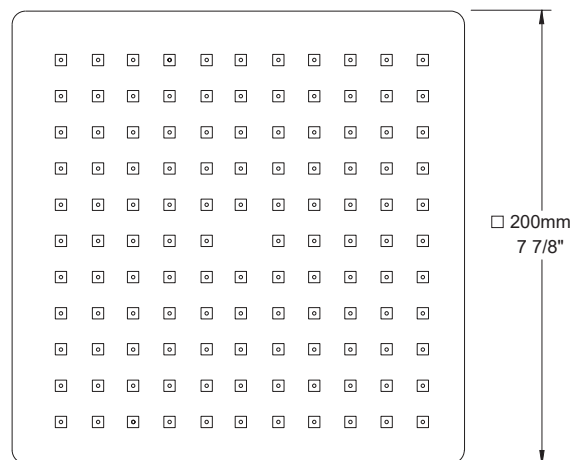
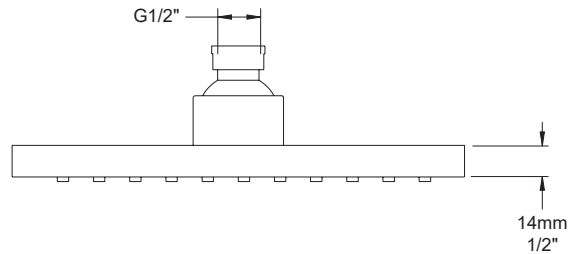

BRA-1612-84-CC

BARIL PRO



Bras de douche mural de 41 cm (16") avec rosace carrée

Finis disponibles

CC : Chrome

KK : Noir mat

FR

Certifications /Standards

ASME A112.18.1 / CSA B125.1



C

41 cm (16") wall mount shower arm with square flange

Available finishes

CC : Chrome

KK : Matte black

EN

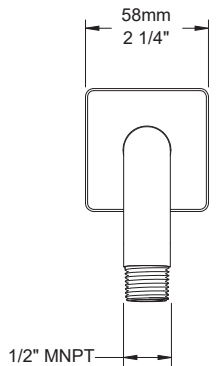
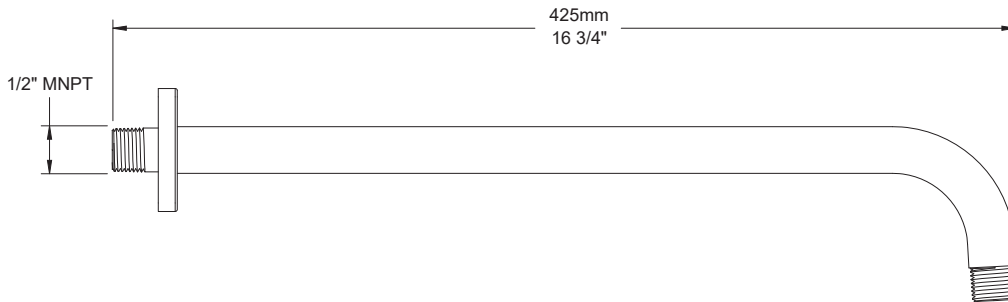



Douchette à glissière 1 jet

Caractéristiques

- Boyau flexible 150 cm (59"), écrou conique tournant avec 2 clapets anti-retour
- Boyau en PVC pour le fini KK ou en métal pour le fini chrome
- Douchette 1 jet facile à nettoyer (max : 2 gpm (7,6 L/min))
- Le curseur a une course de 66 cm (26") sur la barre

Options d'économie d'eau

DGL-2575-71P-xx-150 : 5,7 L/min (1.5 gpm)

DGL-2575-71P-xx-175 : 6,6 L/min (1.75 gpm)

Finis disponibles

CC : Chrome

KK : Noir mat

FR

Certifications /Standards

ASME A112.18.1 / CSA B125.1



C

1-spray hand shower with slide bar

Features

- 150 cm (59") flexible hose, swivel and 2 check valves
- PVC hose in KK finish or metal for chrome finish
- 1-spray easy-to-clean hand shower (max: 2 gpm)
- Slider has 66 cm (26") of travel on the rail

Water saving options

DGL-2575-71P-xx-150 : 5,7 L/min (1.5 gpm)

DGL-2575-71P-xx-175 : 6,6 L/min (1.75 gpm)

Available finishes

CC : Chrome

KK : Matte black

EN

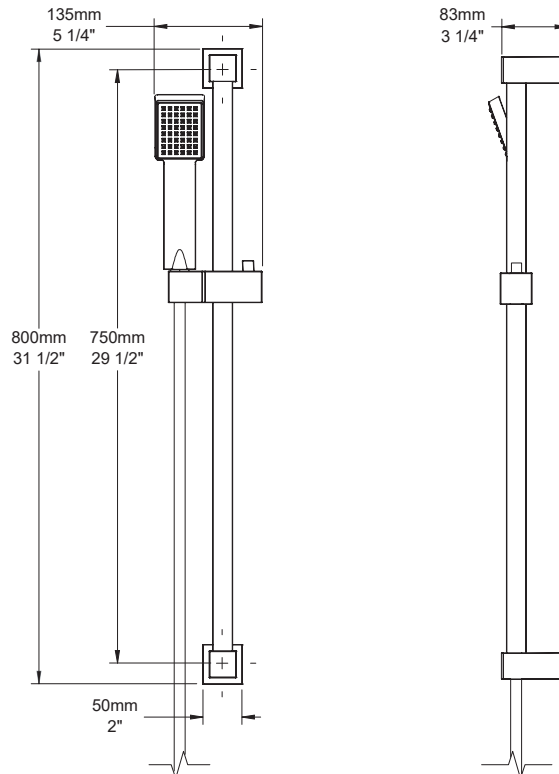

RAC-9004-28-CC

BARIL PRO



Coude de raccordement mural carré (1/2" F)

Finis disponibles

CC : Chrome

KK : Noir mat

FR

Certifications / Standards

ASME A112.18.1 / CSA B125.1



C

Square wall mount supply elbow (1/2" F)

Available finishes

CC : Chrome

KK : Matte black

EN

