

BARIL PRO

Fiche Technique / Spec Sheet
T30-9139-00-CC

Description

- Finition pour valve type P
- Sans vis apparentes
- Plaque de finition à clipser sur une sous-plaque
- Trim for P type valve
- No visible screws
- Trim plate supported by a clip plate

Finis disponibles / Available finishes

- CC: Chrome / Chrome
- KK: Noir mat / Matte black

Certifications / Standards

- ASME A112.18.1 / CSA B125.1

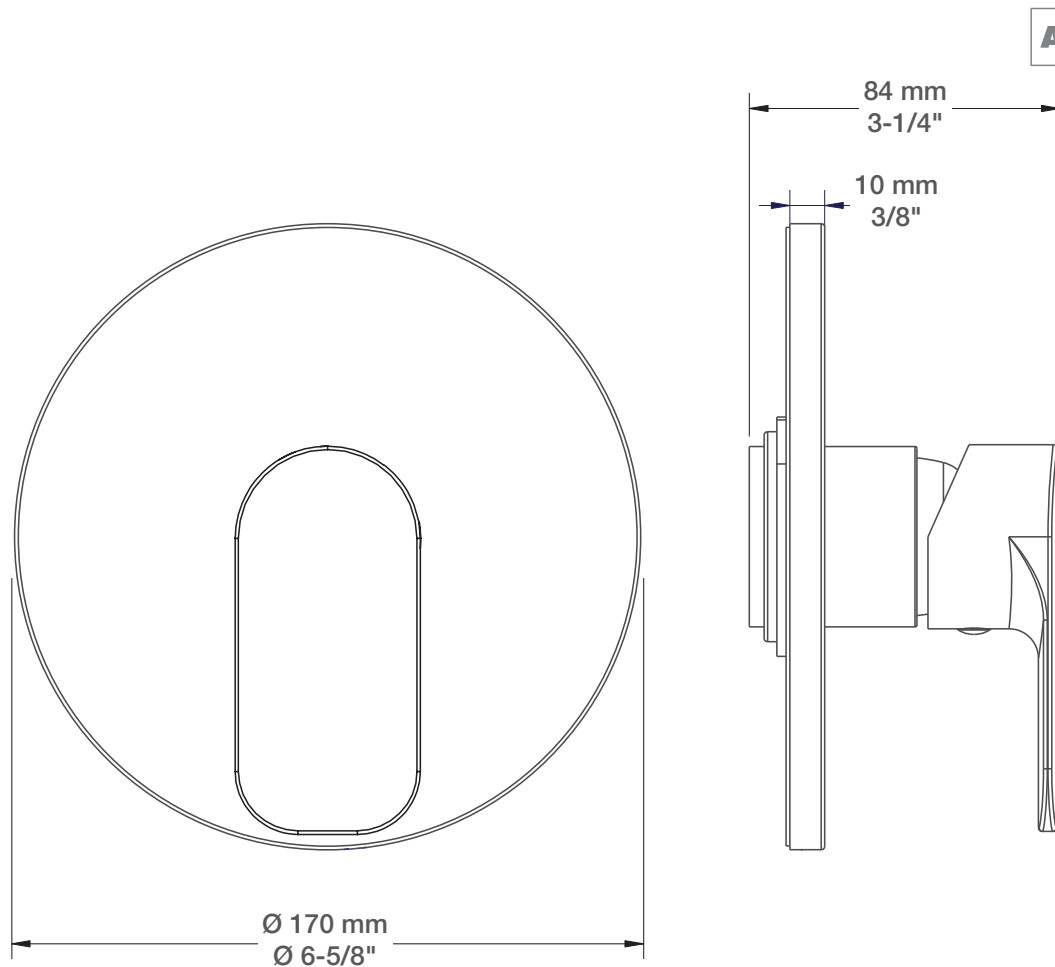

BARIL PRO

Fiche Technique / Spec Sheet
T30-9139-00-KK

Description

- Finition pour valve type P
- Sans vis apparentes
- Plaque de finition à clipser sur une sous-plaque
- Trim for P type valve
- No visible screws
- Trim plate supported by a clip plate

Finis disponibles / Available finishes

- CC: Chrome / Chrome
- KK: Noir mat / Matte black

Certifications / Standards

- ASME A112.18.1 / CSA B125.1

